

---

**Soundcraft**



**User Guide**

---





© Harman International Industries Ltd. 1996  
All rights reserved  
Parts of the design of this product may be protected by worldwide patents.

Part No. ZM0178

Soundcraft is a trading division of Harman International Industries Ltd.

Information in this manual is subject to change without notice and does not represent a commitment on the part of the vendor. Soundcraft shall not be liable for any loss or damage whatsoever arising from the use of information or any error contained in this manual, or through any mis-operation or fault in hardware or software contained in the product.

No part of this manual may be reproduced, stored in a retrieval system, or transmitted, in any form or by any means, electronic, electrical, mechanical, optical, chemical, including photocopying and recording, for any purpose without the express written permission of Soundcraft.

It is recommended that all maintenance and service on the product should be carried out by Soundcraft or its authorised agents. Soundcraft cannot accept any liability whatsoever for any loss or damage caused by service, maintenance or repair by unauthorised personnel.



Harman International Industries Ltd.  
Cranborne House,  
Cranborne Road,  
Cranborne Industrial Estate,  
Potters Bar,  
Herts.,  
England.  
EN6 3JN.

Tel: 01707 665000  
Fax: 01707 660482

---

# Table of Contents

---

<b>Introduction</b>	<b>1.1</b>
<i>Introduction</i>	1.2
<i>Warranty</i>	1.3
<b>Installation</b>	<b>2.1</b>
<i>Dimensions</i>	2.2
<i>Precautions and Safety Instructions</i>	2.3
<i>Mains Installation</i>	2.4
<i>Connections</i>	2.6
<b>Block Diagram</b>	<b>3.1</b>
<b>Functional Description</b>	<b>4.1</b>
<i>Mono Input</i>	4.2
<i>Stereo Input</i>	4.5
<i>FX Return/Aux Master/Group Output</i>	4.8
<i>Matrix Output/Aux Master/Group Output</i>	4.12
<i>Master Section</i>	4.14
<b>Automation</b>	<b>4.19</b>
<i>Introduction</i>	4.20
<i>Mute Scenes/Mute Groups &amp; MIDI Section</i>	4.21
<i>Storing Mute Scenes</i>	4.23
<i>Recalling Mute Scenes</i>	4.24
<i>The 'ALL' Scene</i>	4.25
<i>Introduction to the M1 - M8 Buttons</i>	4.26
<i>Using The M1 - M8 Buttons In Mute Groups Mode</i>	4.27
<i>Using The M1 - M8 Buttons In Mute Scenes Mode</i>	4.28

<i>Storing MIDI Parameters with Mute Scenes</i>	4.29
<i>Setting the Global MIDI Receive/Note On/Off Channel</i>	4.30
<i>Editing MIDI Parameters in Mute Scenes</i>	4.31
<i>Table of MIDI Note Numbers sent/received by K2 mute switches</i>	4.32
<i>MIDI Implementation Chart</i>	4.33
<b>Specification</b>	<b>5.1</b>

# **Introduction**

---

# Introduction

---

K2 is a professional 8-bus sound reinforcement console designed for all types of live sound production. All circuitry on this fully-featured 8-Bus live console is contained on individual vertical channel pcbs, with high quality jack and XLR connectors at the rear of the console.

---

## Frame Sizes

K2 is available in three frame sizes:

- 24 mono input channels
- 32 mono input channels
- 40 mono input channels

Each size includes an additional 4 stereo inputs.

---

## Metering

The console includes a built-in VU output meterbridge, which contains 11 VU meters for the 8 subgroup outputs and the main left, right and mono (centre) outputs. Any of

the four stereo return inputs and the four matrix outputs may be metered instead of the subgroups, by pressing the MTR Select switch at the top of the stereo return and matrix sections.

---

## Power Supply

The K2 uses an external 2U rack-mounting PSU (Power Supply Unit). This rugged unit gives noise-free DC from any mains voltage. Each PSU is fitted with a link connector, allowing two PSUs to be connected to the same console. In this mode the load is shared between the supplies and in the event of a failure of one PSU, the other will automatically take over.

---

## Mute Control Section

This section allows the creation of 8 mute groups plus up to 128 snap-shots of the console's mute switch status, as well as the generation and reception of midi program change messages, allowing the console to remotely control patch changes on your FX rack.

---

# Warranty

---

1 **Soundcraft** is a trading division of Harman International Industries Ltd.

**End User** means the person who first puts the equipment into regular operation.

**Dealer** means the person other than Soundcraft (if any) from whom the End User purchased the Equipment, provided such a person is authorised for this purpose by Soundcraft or its accredited Distributor.

**Equipment** means the equipment supplied with this manual.

- 2 If within the period of twelve months from the date of delivery of the Equipment to the End User it shall prove defective by reason only of faulty materials and/or workmanship to such an extent that the effectiveness and/or usability thereof is materially affected the Equipment or the defective component should be returned to the Dealer or to Soundcraft and subject to the following conditions the Dealer or Soundcraft will repair or replace the defective components. Any components replaced will become the property of Soundcraft.
- 3 Any Equipment or component returned will be at the risk of the End User whilst in transit (both to and from the Dealer or Soundcraft) and postage must be prepaid.
- 4 This warranty shall only be available if:
  - a) the Equipment has been properly installed in accordance with instructions contained in Soundcraft's manual; and
  - b) the End User has notified Soundcraft or the Dealer within 14 days of the defect appearing; and
  - c) no persons other than authorised representatives of Soundcraft or the Dealer have effected any replacement of parts maintenance adjustments or repairs to the Equipment; and
  - d) the End User has used the Equipment only for such purposes as Soundcraft recommends, with only such operating supplies as meet Soundcraft's specifications and otherwise in all respects in accordance Soundcraft's recommendations.
- 5 Defects arising as a result of the following are not covered by this Warranty: faulty or negligent handling, chemical or electro-chemical or electrical influences, accidental damage, Acts of God, neglect, deficiency in electrical power, air-conditioning or humidity control.
- 6 The benefit of this Warranty may not be assigned by the End User.
- 7 End Users who are consumers should note their rights under this Warranty are in addition to and do not affect any other rights to which they may be entitled against the seller of the Equipment.





# **Installation**

---

# Dimensions

---

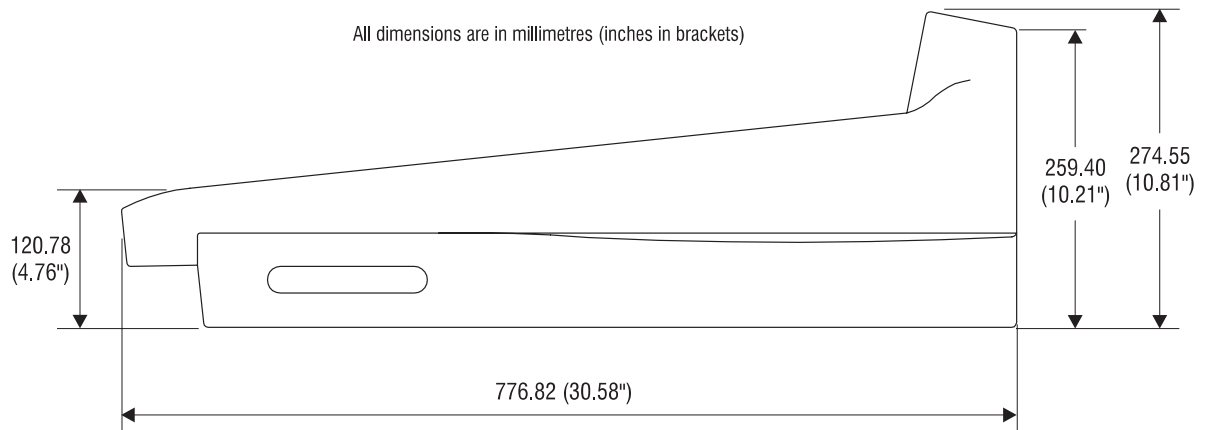

CONSOLE	TOTAL WIDTH
24 ch	1247.0 (49.09")
32 ch	1503.0 (59.17")
40 ch	1735.0 (68.30")

---

# Precautions and Safety Instructions

---

## General Precautions

Avoid storing or using the mixing console in conditions of excessive heat or cold, or in positions where it is likely to be subject to vibration, dust or moisture. Do not use any liquids to clean the fascia of the unit: a soft dry brush is ideal. Use only water or ethyl alcohol to clean the trim and scribble strips. Other solvents may cause damage to paint or plastic parts.

Avoid using the console close to strong sources of electromagnetic radiation (e.g. video monitors, high-power electric cabling): this may cause degradation of the audio quality due to induced voltages in connecting leads and chassis. For the same reason, always site the power supply away from the unit.

**C a u t i o n !      In all cases, refer servicing to qualified personnel.**

---

## Handling and Transport

The console is supplied in a strong carton. If it is necessary to move it any distance after installation it is recommended that this packing is used to protect it. Be sure to disconnect all cabling before moving. If the console is to be regularly moved we recommend that it is installed in a foam-lined flightcase. At all times avoid applying excessive force to any knobs, switches or connectors.

---

## Power Supplies & Cables

Always use the power supply and cable supplied with the mixer: the use of alternative supplies may cause damage and voids the warranty; the extension of power cables may result in malfunction of the mixing console.

**W a r n i n g !      Always switch the power supply off before connecting or disconnecting the mixer power cable, removing or installing modules, and servicing. In the event of an electrical storm, or large mains voltage fluctuations, immediately switch off the PSU and unplug from the mains.**

**W a r n i n g !      Do not replace the fuse with any other type, as this could become a safety hazard and will void the warranty.**

---

## Signal Levels

It is important to supply the correct input levels to the console, otherwise signal to noise ratio or distortion performance may be degraded; and in extreme cases, damage to the internal circuitry may result. Likewise, on all balanced inputs avoid sources with large commonmode DC, AC or RF voltages, as these will reduce the available signal range on the inputs. Note that 0dBu = 0.775V RMS.

Refer to the Specifications section for details of input and output levels.

---

# Mains Installation

---

## General Wiring Procedures

To take full advantage of the excellent signal to noise ratio and low distortion of Soundcraft consoles care must be taken to ensure that incorrect installation and wiring does not degrade the performance of the desk. Hum, buzz, instability and Radio Frequency interference can usually be traced to earth loops and inferior earthing systems. In some areas, especially heavily industrial areas, the incoming mains earth will not be adequate and a separate technical earth for all the audio equipment must be supplied. However, check with your local electricity supply company to ensure that safety regulations are not infringed or negated.

The successful, hum free, installation of a system requires forethought, and the establishment of a set of ground rules, which must be consistently adhered to at all stages of installation.

---

## Initial Wiring Considerations

- For optimum performance, it is essential for the earthing system to be clean and noise free, as all signals are referenced to this earth. A central point should be decided on for the main earth point system, and all earths should be 'star fed' from this point. It is common electrical practice to 'daisy chain' the earths to all electrical outlets but this method is unsuitable for audio installations. The preferred method is to run an individual earth wire from each outlet, back to the system star point to provide a safety earth screen reference for each piece of equipment.  
A separate earth wire should also be run from each equipment rack and area, to the star point. This may or may not be used depending on circumstances, but it is easier to install in the first place, than later when problems arise.  
The location of the star point should be a convenient, easily accessible place, preferably at the rear of the console or in the main equipment rack.
- Install separate 'clean' and 'dirty' mains outlets, wired individually back to the incoming mains distribution box. Use the 'clean' supply for all audio equipment and the 'dirty' supply for all lighting, vending machines etc. Never mix the two systems.
- If necessary, to provide sufficient isolation from mains borne interference, install an isolating transformer. This should be provided with a Faraday Shield which must be connected with earth.
- Never locate the incoming mains distribution box near audio equipment, especially tape recorders, which are very sensitive to electromagnetic fields.
- Ensure that all equipment racks are connected to earth, via a separate wire back to the star point.
- Equipment which has unbalanced inputs and outputs may need to be isolated from the rack to prevent earth loops.

---

## Audio Wiring

Having provided all equipment with power and earthing connections, consideration must be given to the method of providing audio interconnection and adequate screening of those interconnections. This must be done in a logical sequence to avoid problems and assist in the localisation of problem equipment.

- Connect the Monitor system to the console and check for any hum, buzz, or RFI. Only when you are satisfied with the quietness of the console and the monitor system should you proceed with the next step.
- Connect stereo tape recorders, echo and foldback sends one at a time, checking and isolating any connection which degrades performance.
- Connect all other peripheral devices.
- Connect all microphone lines.

By following this sequence much time and future trouble will be saved, and the result will be a quiet, stable system.

---

## Shielding

Audio equipment is supplied with a variety of input and output configurations, which must be taken into consideration when deciding where the screen connections should be made. There are three sources of unwanted signal being impressed on the screen, which are as follows:

- Extraneous electrostatic or electromagnetic fields.
- Noise and interference on the earth line.
- Capacitive coupling between the screen and signal wires.

To minimise the adverse affects of the unwanted coupling to the signal wires, it is important that the screen is connected at one end only, i.e. the screen must not carry any signal current. Any signal on the wires within the screen will be capacitively coupled to the screen. This current will ultimately be returned to the source of the signal, either directly, if the screen is connected at the signal source end, or indirectly via the earthing system, if the signal is connected at the signal destination end. The indirect connection will cause an increase in high frequency cross-talk, and should be avoided wherever possible.

Therefore, in general, always connect the shield only at the signal source end. In high RF areas, the screen can also be connected to earth via a 0.01 $\mu$ F capacitor. This will present a short circuit at RF frequencies, thus lowering the effective shield impedance to ground. However, at low audio frequencies the reactance of the capacitor will be sufficiently high not to cause an earth loop problem.

---

## Points to Remember

- In all cases, use good quality twin screened audio cable. Check for instability at the output.
- Always connect both conductors at both ends, and ensure that the screen is only connected at one end.
- Do not disconnect the mains earth from each piece of equipment. This is needed to provide both safety and screen returns to the system star point.
- Equipment which has balanced inputs and outputs may need to be electrically isolated from the equipment rack and/or other equipment, to avoid earth loops.

It is important to remember that all equipment which is connected to the mains is a potential source of hum and interference and may radiate both electrostatic or electromagnetic radiation. In addition, the mains will also act as a carrier for many forms of RF interference generated by electric motors, air-conditioning units, thyristor light dimmers etc. Unless the earth system is clean, all attempts to improve hum noise levels will be futile. In extreme cases there will be no alternative but to provide a completely separate and independant 'technical earth' to replace the incoming 'noisy earth'. However, always consult your local electricity supply authority to ensure that safety regulations are not being infringed.

# Connections

The K2 uses two different types of audio connector: 3-pin XLR and 1/4" 3-pole jacks. This section describes how to connect external equipment to the console. Correctly-made cables of the proper type will ensure peak performance from your mixer.

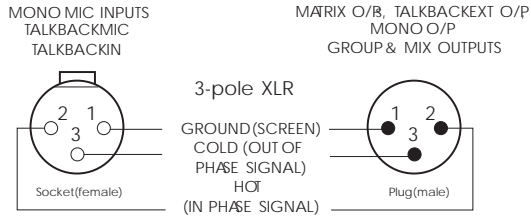

1/4" Stereo Jack Plug used as balanced Input/Output:  
Hi-Z Input, Stereo Inputs, 2-Track Inputs,  
Oscillator O/P Aux O/B

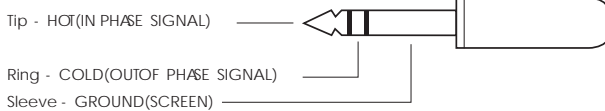

1/4" Stereo Jack Plug used as a ground compensated output:  
Direct O/B, Monitor O/B

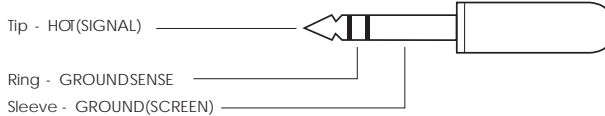

1/4" Stereo Jack Plug used as an Insert Point on:  
Mono Inputs, Stereo Inputs, Group Outputs, Mono Mix  
and Main Mix Outputs

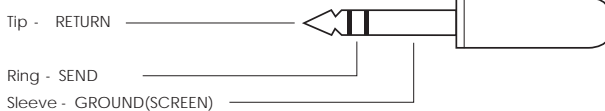

1/4" Stereo Jack Plug used as a Stereo Output:  
Headphones

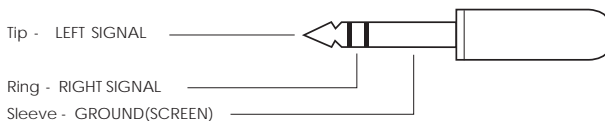

The console also uses industry-standard MIDI connectors. The pin-outs are as shown below. Note that the MIDI IN is opto-isolated.

## DIN Connectors

The MIDI IN signal is buffered by an opto-isolator.

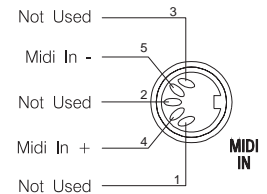

## MIDI THRU

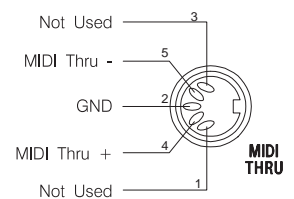

## MIDI OUT

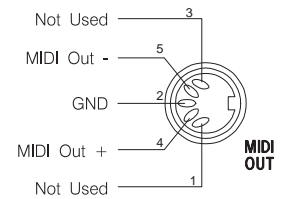

# **Block Diagram**

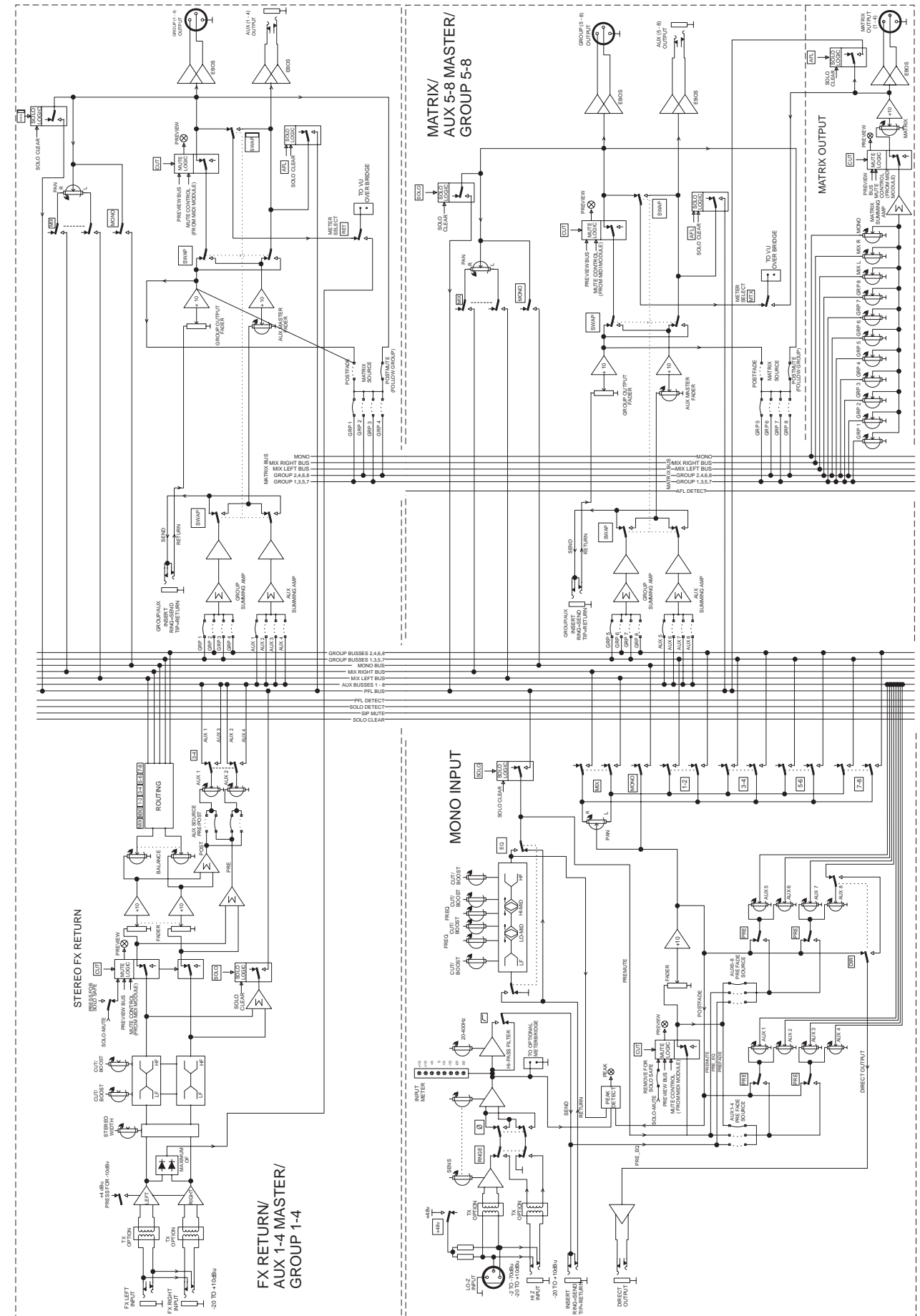



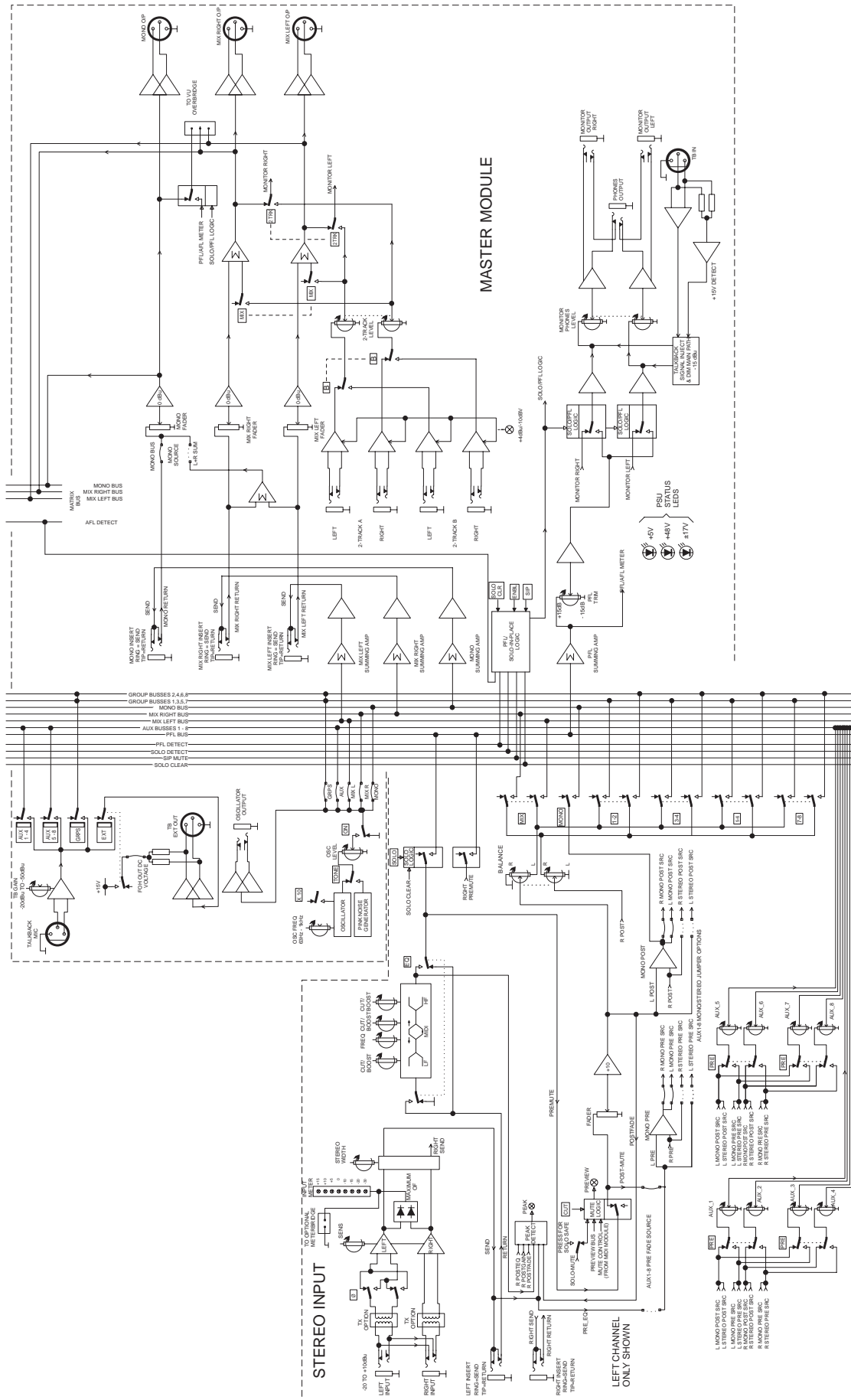



# **Functional Description**

# Mono Input

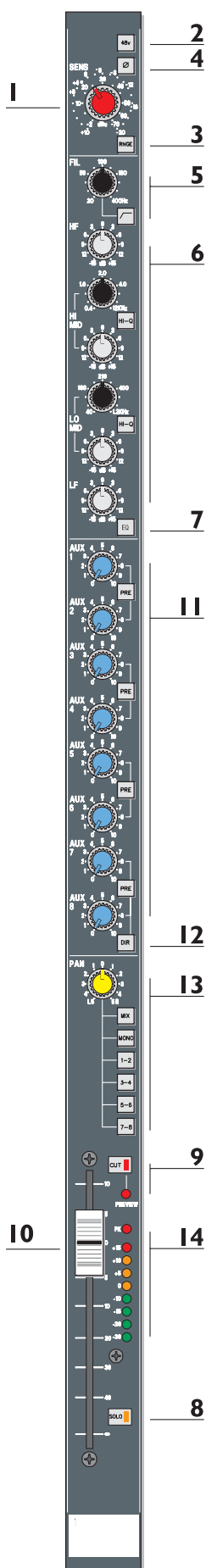

**1 SENS** adjusts the sensitivity of both XLR and HIGH IMPEDANCE(HI-Z jack) inputs. Both inputs are electronically balanced. XLR input sensitivity: -2dBu to -70dBu, +10dBu to -20dBu (switched range.) High Impedance input sensitivity: +10dBu to -20dBu

**2** The **48V** switch applies 48V phantom power to the input XLR.

**3 RNGE** switches the input to the lower sensitivity range to allow line level signals to be used. The signal is still taken from the input XLR, unless a jack is inserted into the HI-Z input socket, when signal from that is used instead. The break contacts of the Hi-Z jack are paralleled to the XLR input, so that 48V is not available via the jack.

**4 PHASE** reverses the phase of the selected input.

**5 HI-PASS** switches in the high-pass filter. The frequency is varied from 20Hz to 400Hz using the **FIL** control.

The module insert point is pre-EQ , pre-fader.

**6** The EQ section is four band, with shelving HF and LF, and peaking sweep high and low mid sections.

The **HF** and **LF** sections give +/-15dB cut/boost at 12KHz and 60Hz respectively. The **Lo-mid** section gives +/-15dB cut/boost at 40Hz-1.2KHz: its **Hi-Q** switch changes the Q from 1.3 to 2.6 when pressed.

The **Hi-mid** section gives +/-15dB cut/boost at 400Hz-12KHz.

The **Hi-Q** switch changes the Q from 1.3 to 2.6 when pressed.

**7** The section is switched in by the **EQ** switch.

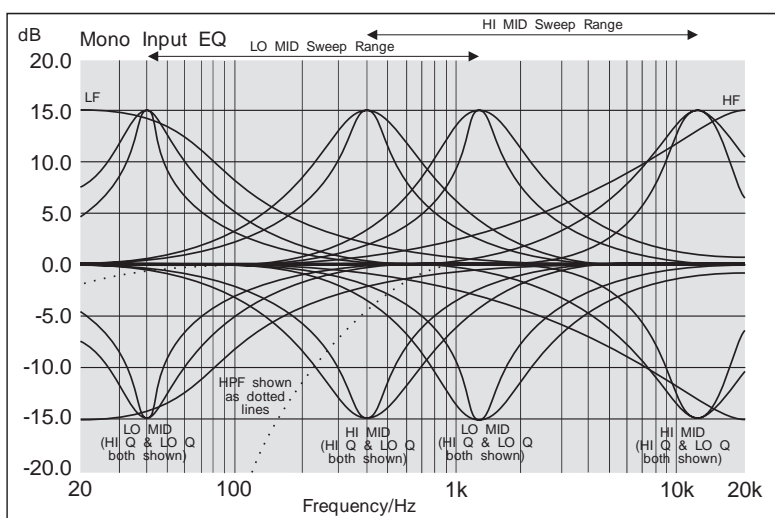

**8** The electronically latching **SOLO** switch feeds the pre-fade, pre-mute signal to the monitor output and phones output. If **AUTO CANCEL** (on the master module) is active, then any previously active **SOLOs** or **AFLs** will be cancelled. The **PFL** can be remotely cleared either by the **SOLO CLEAR** button on the master, or by any other **SOLO** or **AFL** if **AUTO CANCEL** is active. If **SIP** mode is selected on the master module, the button functions as solo in place, muting all other channels. An internal jumper allows the mono input to be made safe from muting when another channel is soloed, or from the **MIDI** mute system.

**9** The signal in the module is turned on and off by the **CUT** switch, and the **MIDI** muting system. The module is assigned to a **MIDI** mute scene by pressing the **CUT** switch and then pressing the **STORE** button on the **MIDI** control module. When the module is muted by the **MIDI** system, the **CUT** switch illuminates. The **PREVIEW LED** is flashed by the **MIDI** control module when **PREVIEW** mode is selected, to indicate that the channel is programmed into a selected mute scene.

**10** Post-fader signal level is controlled by a **100mm fader**.

**11** Signal is sent to the **AUX 1-8** busses via individual level pots. These have unity gain when fully clockwise, and are switched pre- or post-fader in pairs by the **PRE** buttons. The pre- fade signal may be sourced pre-fade and post mute, pre-mute or pre-EQ and pre-insert, in three blocks of four sends, using push-on jumpers. These jumpers are near to the lower edge of the pcb so they can be changed easily when the bottom of the console is removed.

**12** The **DIR** switch switches **Aux 8** away from its bus and connects it to the **Direct Output**. When **DIR** is not pressed, the **Direct Output** is fed directly with the post-fader signal.

**13** The signal is sent to the stereo mix bus, mono bus and 8 group busses using the **MIX, MNO, 1-2, 3-4, 5-6, 7-8** switches and **PAN**, which gives a 4.5dB centre drop. The mono bus is fed directly from the post-fader signal.

**14** An 8-segment LED bargraph meter next to the fader meters the signal at the input amplifier. The meter has a peak type response. The **Peak LED**, which is positioned above the meter, monitors the input amp, EQ output and post fader signals, and illuminates at 6dB before clipping.

## Jumper Options

Jumper	Function	Default
JMP1	Aux 5-8 Pre-EQ	
JMP2	Aux 5-8 Pre-Mute	
JMP3	Aux 5-8 Pre-Fade	Pre-Fade
JMP4	Aux 1-4 Pre-EQ	
JMP5	Aux 1-4 Pre-Mute	
JMP6	Aux 1-4 Pre-Fade	Pre-Fade
JMP7	Remove for SIP SAFE	Fitted
JMP8	Fit for MIDI MUTE SAFE	

## Rear Connectors

### INPUT (3 pin female XLR)

- Pin 1 ..... Ground
- Pin 2 ..... Signal Hot
- Pin 3 ..... Signal Cold

### Hi-Z INPUT (1/4" TRS Jack)

- Tip ..... Signal Hot
- Ring ..... Signal Cold
- Sleeve ..... Ground

### INSERT (1/4" TRS Jack)

- Tip ..... Return Signal
- Ring ..... Send Signal
- Sleeve ..... Ground

### DIRECT OUTPUT (1/4" TRS Jack)

- Tip ..... Signal Hot
- Ring ..... Ground Sense
- Sleeve ..... Ground

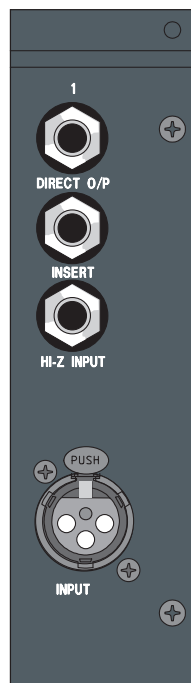

# Stereo Input

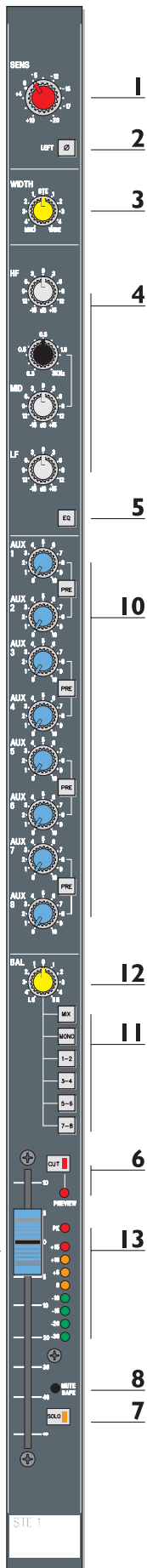

The left and right inputs are line-level, electronically balanced, from a pair of 1/4" jacks on the rear panel. If a signal is plugged into the left jack only, it is fed to both left and right signal paths.

1 **SENS** adjusts the sensitivity the inputs from +10 to -20dBu.

2 Left **PHASE** inverts the phase of the left channel.

3 The **WIDTH** control varies the width of the stereo image from mono, through normal stereo (centre detent) to phase-enhanced stereo (fully clockwise).

The module left and right insert points are pre-EQ, pre-fader.

4 The EQ section is three band, with shelving high and low frequencies and a sweep peak/dip mid band.

The **HF** control gives +/-15dB cut/boost at 12KHz.

The **LF** control gives +/-15dB cut/boost at 60Hz.

The **MID** control gives +/-15dB cut/boost at a centre frequency set by the **MID FREQ** control. This control varies the centre frequency from 300Hz to 3KHz, with a Q of 1.0.

5 The EQ is switched in by the **EQ** switch.

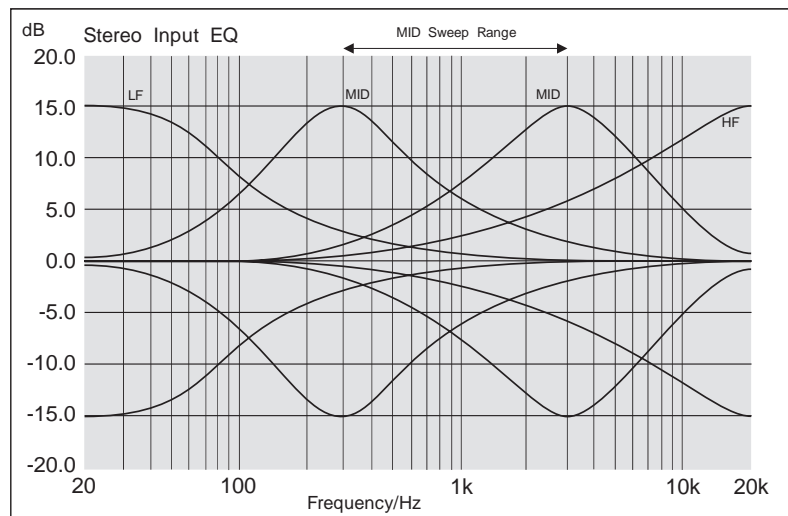

6 The signal in the module is turned on and off by the **CUT** switch and the MIDI muting system. The module is assigned to a MIDI mute scene by pressing the CUT switch and then pressing the STORE button on the MIDI control module. When the module is muted by the MIDI system, the CUT switch illuminates (except if Mute safe switch is pressed). The PREVIEW LED is flashed by the MIDI control module when PREVIEW mode is selected, to indicate that the channel is programmed into a selected mute scene.

7 The **SOLO** button switches a mono sum of the pre-fader, post EQ signal to the monitor/phones outputs. This switch is part of the autocancel and solo clear system. If SIP mode is selected on the master module, the button functions as solo-in-place, muting all other channels.

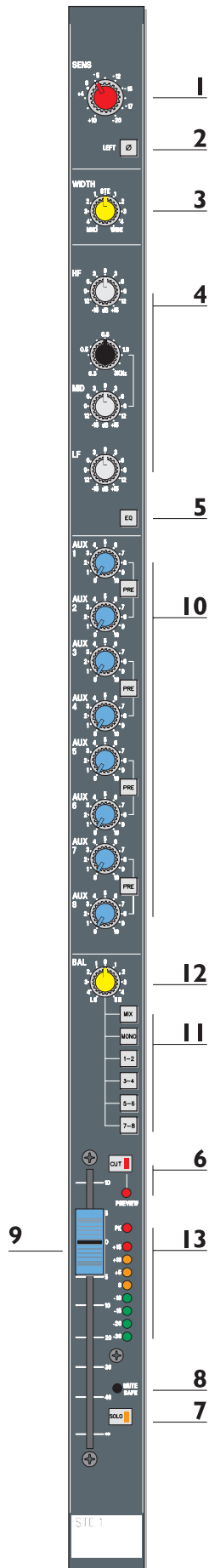

**8** The **MUTE SAFE** switch allows the module to be made safe from muting if another channel is soloed, or from the MIDI muting system. The switch is accessible via a screwdriver hole in the front panel: latching the switch in gives mute safe.

**9** Post-fader signal level is controlled by a **100mm stereo fader**.

**10** The signal is routed to the 8 Aux busses by the **AUX 1-8** controls. These are fed from a combination of pre or post-fade mono signals; the pre or post fader status is selected on the front panel for each pair of sends using the PRE switches. The pre or post fader source for the Aux 1-8 can be either stereo (Left feeds odd sends, right feeds even) or a mono sum. This is selected by internal jumpers. The pre-fade feed to all auxes can be selected to be either pre-or post-EQ, by a jumper.

**11** The post-fade signal is routed to the stereo mix, mono (centre) bus and 8 group busses via the **MIX, MNO, 1-2, 3, 5-6, 7-8** buttons. These switches (except MNO) are fed from the output of the Balance control, with odd busses fed from the left channel and even busses fed from the right. The MNO switch is fed from the post-fade mono sum signal.

**12** The **balance control** varies the relative levels of left and right channels. When rotated fully in one direction from the centre position, the level of one channel is increased by 4.5dB, while the other channel is reduced to zero. Each channel has unity gain when the control is centred.

**13** An 8-segment **LED bargraph meter** next to the fader meters the signal at the input amplifier. The meter has a peak type response. The **Peak** LED, which is positioned above the meter, monitors the input amp, EQ output and post fader signals, and illuminates at 6dB before clipping.

### Jumper Options

Jumper	Function	Default
J1	Aux 1,3,5,7 Post Source Mono/stereo (L)	Mono (in stereo, odd sends from L, even from R)
J2	Aux 2,4,6,8 Post Source Mono/stereo (R)	Mono (in stereo, odd sends from L, even from R)
J3	Aux 1,3,5,7 Pre Source Mono/stereo (L)	Mono (in stereo, odd sends from L, even from R)
J4	Aux 2,4,6,8 Pre Source Mono/stereo (R)	Mono (in stereo, odd sends from L, even from R)
J5	Mono Pre-source source (pre-fade or pre-eq) (L)	pre-fade
J6	Mono Pre-source source (pre-fade or pre-eq) (R)	pre-fade



## Rear Connectors

### INPUT LEFT and RIGHT (1/4" TRS Jacks)

Tip ..... Signal Hot  
Ring ..... Signal Cold  
Sleeve ..... Ground

### INSERT POINT LEFT and RIGHT

Tip ..... Return Signal  
Ring ..... Send Signal  
Sleeve ..... Ground

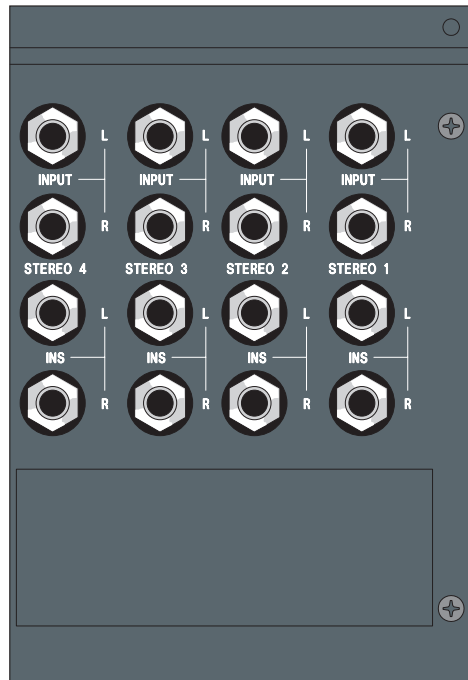

# FX Return/Aux Master/Group Output

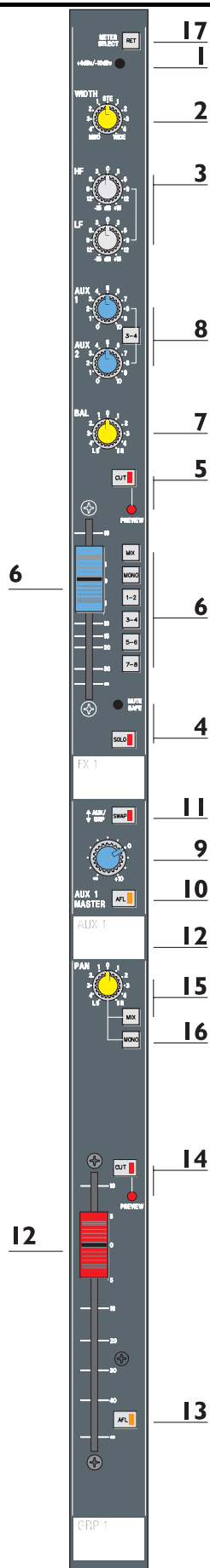

Four FX Return/Aux Master/Group Output sections are fitted, forming half the output section in the console. Each section contains:

- a stereo effects input with 60mm fader, 2-band EQ and 2 Auxiliary sends
- an aux master output control
- a group output section, with 100mm fader

The inputs to the group and aux summing amps can be swapped, to allow fader control of the auxiliary outputs.

## FX Return

The Stereo Return section is completely separate electronically from the group section.

1 The input sensitivity is switchable between **-10dBV** and **+4dBu** by means of a switch mounted internally on the PCB. The switch is accessible via a screwdriver hole in the front panel. When the switch is in the “up” position, the sensitivity is +4dBu.

2 The signal then passes to the **WIDTH** control, which varies the image from mono (anticlockwise) through normal stereo (centre detent) to phase-enhanced wide stereo (clockwise).

3 The 2-band EQ section gives 15dB cut/boost at 12kHz, controlled by the **HF** pot, and 60Hz, controlled by the **LF** pot. The EQ has a shelving response.

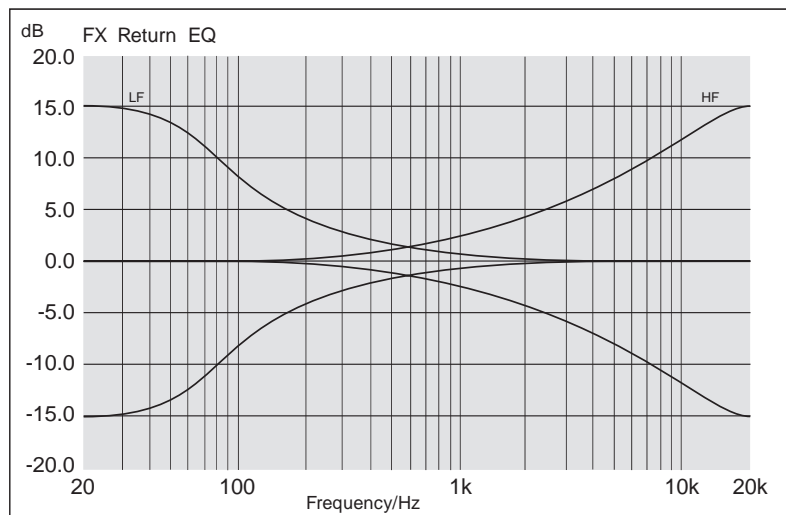

4 The electronically latching **SOLO** switch switches a pre-fade, post-EQ mono sum of the signal onto the monitor and phones outputs. This switch is part of the AUTOCANCEL system and can be cleared using SOLO CLEAR on the master module. If SIP mode is selected on the master module, the button functions as solo in place, muting all other channels. A switch, which is accessible via a screwdriver hole, allows the stereo return to be made safe from muting if another channel is soloed: latching the switch in results in mute safe.

**5** The stereo return signal is muted by the **CUT** switch, and by the MIDI muting system. When the return is muted from MIDI control module, the switch LED illuminates. The return is assigned to a MIDI mute scene by pressing the **CUT** switch then pressing the **STORE** button on the MIDI control module. The **PREVIEW LED** is flashed by the MIDI control module when preview mode is selected, to indicate that the return is assigned to a selected mute scene.

**6** The return level is controlled by the fader, and is sent via the balance control to the **MIX, MNO, 1-2, 3-4, 5-6, 7-8** buttons, which control routing to the stereo mix, mono (centre) and 8 group busses.

**7** The **BALANCE** control varies the relative levels of left and right channels. When rotated fully in one direction from the centre position, the level of one channel is increased by 4.5dB, while the other channel is reduced to zero. Each channel has unity gain when the control is centred.

**8** Two Aux send controls, **AUX 1** and **AUX 2** route a mono sum of either the pre-fade(post- cut) or post fade signals (selectable for each Aux by internal jumpers) to the Aux 1 and 2 busses. The 3-4 button switches the pots to feed Aux busses 3 and 4 instead.(See the jumper settings on the next page for details.)

## AUX MASTER

The Auxiliary master is separate from the group section.

**9** The output level is controlled by the **AUX** level control. The gain is 10dB when fully clockwise.

**10** The **AFL** button switches the post fader signal to the monitor/phones output. The switch is part of the autocancel and solo clear system, but is not part of the SIP system.

**11** The **SWAP** switch reverses the bus feed to the group and aux summing amps, so that the aux bus is controlled by the 100mm fader, and also fed via the insert point. The meter feed is always from the 100mm fader output, allowing aux signals to be metered when in “swap” mode. The group-to-mix routing and pan controls, and group-to-mono routing always stay with the group signal. The matrix feed may be jumper-configured to follow group or to follow the linear fader. See the diagram below.

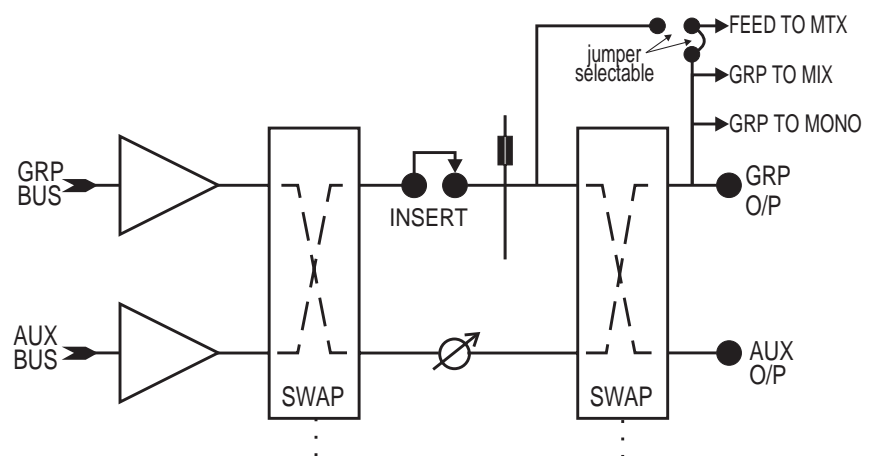

## Group Master

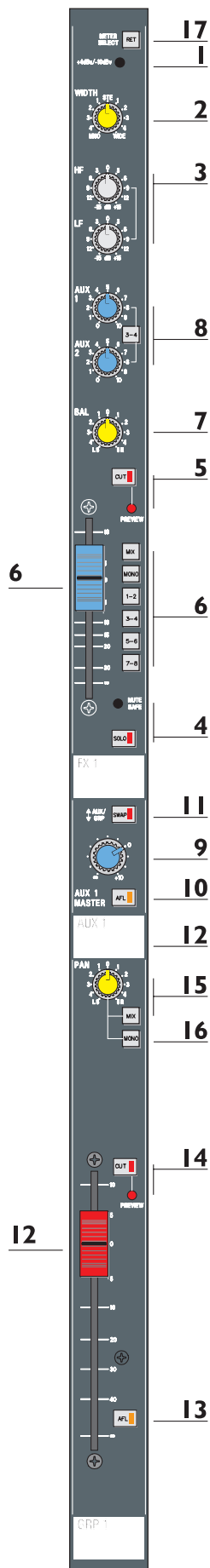

**12** The group fader controls the level of the signal from the summing amplifier fed to the insert send, with 10dB gain at the top of the fader.

The insert point is pre-fade.

**13** The electronically latching **AFL** switch feeds the post fade group signal to the monitor output and phones output.

If solo AUTO CANCEL is selected on the master module, then the AFL will cancel any other active SOLOs or AFLs. The AFL may also be cleared with the master SOLO CLEAR function. AFL does not activate the SIP system.

**14** The **CUT** switch mutes the signal to the group output and stereo mix bus (if selected). The **PREVIEW** LED is flashed by the MIDI control module when PREVIEW mode is selected, to indicate that the channel is programmed into a selected mute scene.

**15** The **MIX** switch routes the post-fade group signal to the left and right stereo mix busses, via the PAN control, which has a 4.5dB centre drop.

**16** The **MNO** switch (illuminated, green LED) routes the post-fade group signal to the mono bus. The pan pot has no effect on the mono bus signal.

## Metering

The group output level is metered (post fader) by the VU meterbridge. The meter is calibrated for OVU at +4dBu output.

**17** The **RET** switch switches the meter to read the stereo return Left and Right signals (the highest of left or right, post-EQ) instead of the group output.

## Jumper Options

Jumper	Function	Default
JMP7	Feed to matrix Pos 1 - post-fade Pos 2 - follow group	Pos 2 - follow group
JMP5	Group CUT Latch Fitted - MIDI Mute Safe	NOT Fitted.
JMP21	FX Feed to Aux 1 (3) Pre-fade or Post-fade	Post-fade
JMP22	FX Feed to Aux 2 (4) Pre-fade or Post-fade	Post-fade

## Rear Connectors

### FX INPUT L,R (1/4" TRS Jack)

Tip ..... Signal Hot  
Ring ..... Signal Cold  
Sleeve ..... Ground

### INSERT POINT (1/4" TRS Jack)

Tip ..... Return signal  
Ring ..... Send signal  
Sleeve ..... Ground

### GROUP OUTPUT (3 pin male XLR)

Pin 1 ..... Ground  
Pin 2 ..... Signal Hot  
Pin 3 ..... Signal Cold

### AUX OUTPUT (1/4" TRS Jack)

Tip ..... Signal Hot  
Ring ..... Signal Cold  
Sleeve ..... Ground

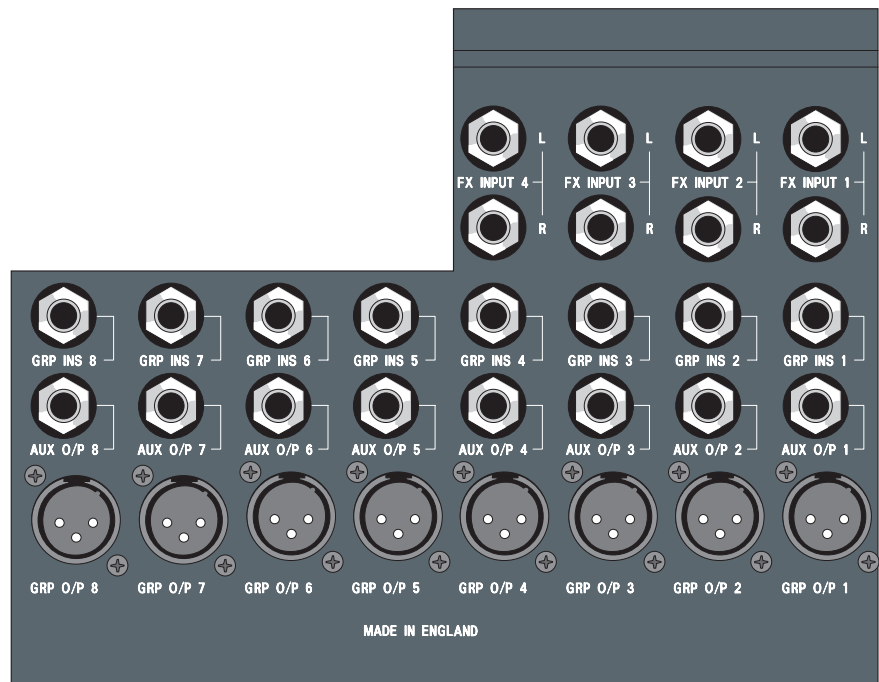

# Matrix Output/Aux Master/Group Output



5

1

2

4

3

Four Matrix Output/Aux Master/Group Output sections are fitted, forming the second half of the output section. Each section module contains:

- 1 x 1 matrix output section
- an aux master output controls
- a group output section, with 100mm fader

The inputs to the group and aux summing amps can be swapped, to allow fader control of the auxiliary outputs.

## Matrix

The Matrix Output section is separate electronically from the group section.

1 The inputs to the matrix section are controlled by the eleven **receive pots**. These control the contribution from the 8 group outputs, left and right mix and mono (centre) outputs.

2 The output signal is controlled by the **MATRIX** master rotary fader.

3 The **AFL** switch switches the post-fade output to the monitor/phones outputs. This switch is not part of the SIP system.

4 The matrix output signal is muted by the **CUT** switch, and by the MIDI muting system. When the matrix is muted from MIDI control module, the switch LED illuminates. The PREVIEW LED is flashed by the MIDI control module when preview mode is selected, to indicate that the matrix is assigned to a selected mute scene.

The matrix is assigned to a MIDI mute scene by pressing the CUT switch then pressing STORE on the MIDI control module.

## Metering

The group output level is metered (post fader) by the VU meterbridge. The meter is calibrated for OVU at +4dBu output.

5 The **MTX** switch switches the meter to read the Matrix Output level instead of the group output.

## Aux Master

See the description on page 4.9

## Group Master

See the description on page 4.10

## Jumper Options

Jumper	Function	Default
JMP2	Feed to matrix Pos 1 - post-fade Pos 2 - follow group	Pos 2 - follow group
JMPI	Group Cut Latch Fitted - MIDI Mute Safe	NOT Fitted.
JMP301	Matrix CUT Latch Fitted - MIDI Mute Safe	NOT Fitted.

## Rear Connectors

MATRIX OUTPUT (3 pin male XLR)

Pin 1 ..... Ground

Pin 2 ..... Signal Hot

Pin 3 ..... Signal Cold

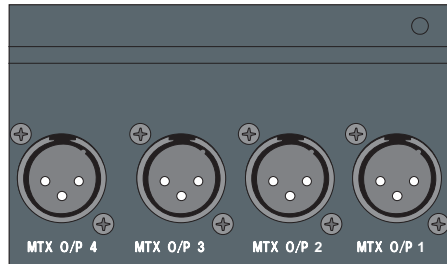

# Master Section

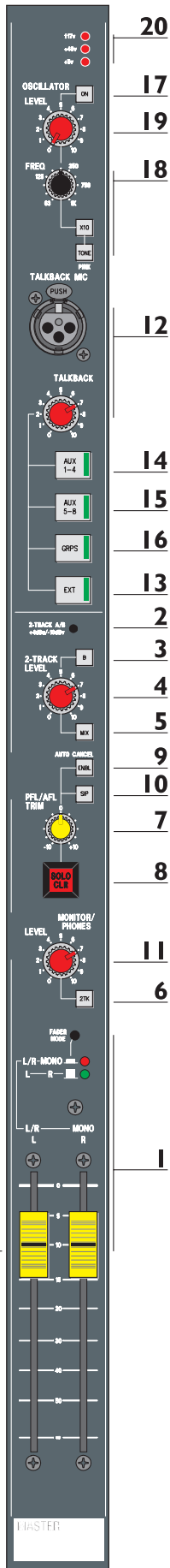

The master section contains the stereo mix output, the operator's headphones and monitor speaker outputs, a pink noise/sine wave test oscillator, the solo mode controls and master solo clear function, internal/external talkback functions and PSU status indicator LEDs.

## Main Outputs

1 There are two **master faders**, these may be set by the **Fader Mode** switch, which is accessible through a screwdriver hole in the front panel, to work in one of two modes:

- L/R - Mono: in this mode the main left and right outputs are controlled together by the left fader, and the mono output is controlled by the right fader.
- L - R: this allows you to control the main left and main right outputs individually, with the mono output having no fader control, its level is fixed at 0dB.

The adjacent LEDs show at a glance which mode is selected.

The source of the mono fader is normally the mono bus itself, but internal jumpers allow this to be changed to be a derived mono sum of the pre-fade (post insert) left and right signals. The left/right sum is fed to the mono output after the mono insert return, which is then disconnected. The mono insert send can still function as a pre-fade output from the mono bus even when the main output has been jumpered to L/R sum.

## 2-Track Returns

There are two 2-track return inputs: 2TKA and 2TKB

2 A switch which is accessible through a screwdriver hole allows the sensitivity of both inputs to be set to either **+4dBu** or **-10dBV**. When the switch is in the "up" position, the sensitivity is +4dBu.

3 The **B** button selects one or the other of the 2-track inputs.

4 The selected signal is fed to the signal to the **2-Track Level** control.

5 The **MIX** button routes the signal to the stereo mix outputs, post the master faders.

6 The selected 2-track input can be monitored on the monitor/phones outputs before it is routed to mix, by pressing the **2TRK** button on the monitor output section.



## Solo System

A solo system of pre-fade (PFL)(for inputs) and after-fade (AFL)(for outputs) feeds the monitor and phones outputs. Normally, all active PFL and AFL signals are summed together and fed to the monitor and phones outputs. This overrides the stereo mix or 2-track signal which is normally fed to the monitor/phones output.

**7** The **PFL/AFL TRIM** control gives +/-10dB of level trim for PFL/AFL signals.

**8** The **SOLO CLR** button lights when any PFL, or AFL is active: pressing it will clear a PFL or AFL.

**9** When **AUTO CANCEL** is activated by the **ENBL** button, pressing any AFL or SOLO button will cancel any other which is currently active, so only one AFL or SOLO can be active at once.

**10** The **SIP** (Solo-In-Place) button disables the automatic switching of the monitor/phones outputs to the PFL/AFL signal, and causes a solo mute bus to be activated when any mono or stereo input or stereo return has its SOLO button pressed. The solo mute bus then mutes all other channels except those which have either been jumper-programmed to be "SAFE", or have their own SOLO buttons pressed. The Group and Aux output AFLs do not trigger the solo-in-place system.

**WARNING:** *Because Solo-In-Place works by muting channels, it cannot be used during a performance. Ensure that the SIP button is turned off after the sound check!*

The current solo signal is metered by the mono (centre) VU meter -see "metering" below.

## Monitor and Headphones Outputs

**11** The Monitor Outputs and Headphones output share a common signal source and are controlled by the **Monitor/Phones Level** control.

The phones output socket is a stereo 1/4" jack mounted underneath the arm rest. The signal source for these outputs is selected using the 2TRK button (see item 6). If this is not pressed, the post-fade stereo mix signal is fed to the monitor outputs. If 2TRK is pressed, the post-fade signal from the 2-Track return section is fed to the monitor outputs. Any SOLO or AFL operation will override the mix or 2-track signal.

## Metering

Two VU meters in the overbridge read the post-fade stereo mix or 2-track return levels. A third VU meter reads the post-fade mono (centre) level. If a SOLO or AFL is operated, the mono (centre) meter switches to display the PFL/AFL level (pre the solo trim control).

## Talkback

The talkback system allows communication by the operator to the Group and Aux outputs, and to and from the front of house (FOH) console.

**12** The **TALKBACK** pot controls the level of the talkback mic input, from a 3-pin **XLR** on the master module front panel. The sensitivity of the mic input is variable between -20dBu and -50dBu.

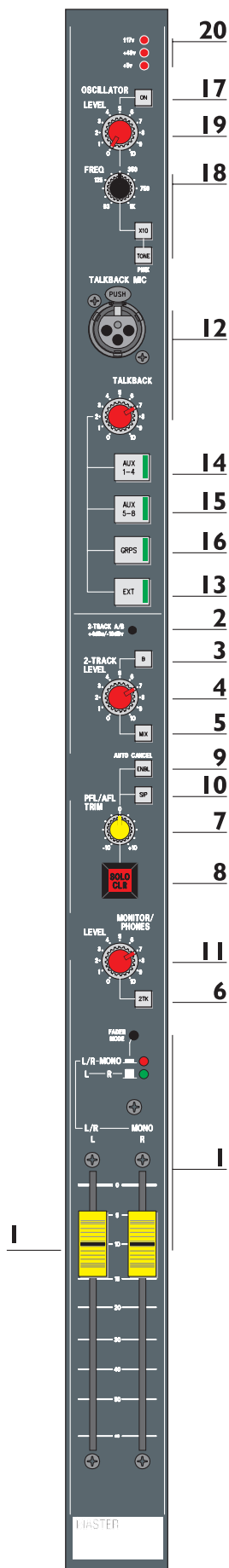

**13** The **EXT** button initiates talkback to the monitor console using a Soundcraft proprietary system: the talkback mic signal is switched to the EXT OUT XLR, with a +15v DC common-mode voltage to signal the Monitor console (e.g. SM12, 16, 24 or Delta Monitor) that talkback is occurring. An internal jumper disables the common-mode DC voltage, to allow use with non-Soundcraft desks. If a 15V common-mode voltage is detected on the TB IN XLR, indicating talkback from the monitor console, then the TB IN signal is switched to the 'phones output, dimming the existing signal by 15dB. The EXT switch also lights.

**14** The **AUX 1-4** button routes the talkback microphone signal to the 1-4 Auxiliary busses.

**15** The **AUX 5-8** button routes the talkback microphone signal to the 5-8 Auxiliary busses.

**16** The **GRP** button routes the talkback mic signal to the 8 Group busses.

## Oscillator

**17** The oscillator, activated by the **ON** switch, produces pink noise.

**18** The **TONE** button switches the signal from pink noise to sine wave, with frequency variable between 63Hz and 1kHz by the **FREQ** pot. The **X10** button increases the frequency up to 630Hz and 10kHz.

**19** The oscillator signal is fed to the group, aux, stereo and mono mix busses; any of these can be disabled using internal jumpers. The oscillator output is also available, on a balanced 1/4" jack on the rear connector panel. The **LEVEL** pot adjusts the level from off to 10dB above nominal.

## PSU Status Indicators

**20** The three **PSU Status** Indicator LEDs show that the PSU rails (+48v, +/-17v [both sets of rails] and +5V) are working.

## Jumper Options

Jumper	Function	Default
JMP1	FOH Out DC Voltage Enabled/disabled	Enabled
JMP2	Oscillator routing to Groups Enabled/disabled	Enabled
JMP3	Oscillator routing to Aux Enabled/disabled	Enabled
JMP4	Oscillator routing to MIX L/R Enabled/disabled	Enabled
JMP5	Oscillator routing to MONO Enabled/disabled	Enabled
JMP6	Mono Output Source Mono bus or L+R Sum	Mono Bus

## Rear Connectors

### EXTERNAL TALKBACK IN, TALKBACK MIC IN (3 pin female XLR)

- Pin 1 ..... Ground
- Pin 2 ..... Signal Hot
- Pin 3 ..... Signal Cold

### INSERT POINTS (1/4" TRS Jack)

- Tip ..... Return signal
- Ring ..... Send signal
- Sleeve ..... Ground

### 2-TRACK RETURNS (1/4" TRS Jack)

- Tip ..... Signal Hot
- Ring ..... Signal Cold
- Sleeve ..... Ground

### MONITOR OUTPUTS (1/4" TRS Jack)

- Tip ..... Signal Hot
- Ring ..... Ground Sense
- Sleeve ..... Ground

### MIX L,R,MONO OUTPUTS , TALKBACK OUT(3-pin male XLR)

- Pin 1 ..... Ground
- Pin 2 ..... Signal Hot
- Pin 3 ..... Signal Cold

### OSCILLATOR OUTPUT (1/4" TRS Jack)

- Tip ..... Signal Hot
- Ring ..... Signal Cold
- Sleeve ..... Ground

### PHONES OUTPUT (1/4" TRS Jack) (mounted under the arm-rest)

- Tip ..... Left Signal
- Ring ..... Right Signal
- Sleeve ..... Ground

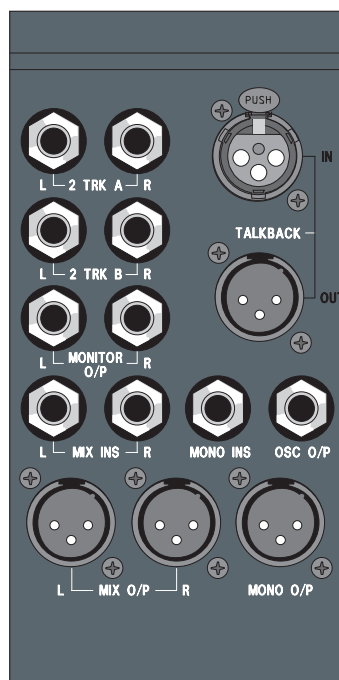

# **Automation**

---

# Introduction

---

The MIDI/ Scene Set module provides two main functions: the **Mute Scenes Controller**, and the **Mute Grouping System**

---

## Mute Scenes Controller

This allows the status of all the input and output cut switches to be memorised, and stored, in battery-backed memory within the console, as one or more “snapshots” or Mute Scenes. Up to 128 scenes are possible internally, more are possible if a MIDI SysEx data filer device is used to off-load the console’s internal memory.

---

## Mute Grouping System

The Mute Grouping System works independently of the Mute Scenes Controller. It allows up to 8 mute groups to be set up and used in the same way that conventional mute groups would be.

---

## MIDI Control

The integration of **MIDI** within the system further extends the power of the “Scene Set” automation, because MIDI program changes can be sent out automatically as a Mute Scene is selected (or “Recalled”) and these can be used to select relevant patches on outboard FX devices, etc. Alternatively, by only storing program change messages and leaving the console mutes the same in each scene, the system can be used simply to change FX programs from the console.

The system will also respond to incoming program change messages, so the console can be stepped through its mute scenes by remote control, or automatically by a MIDI sequencer if necessary.

The MIDI capabilities also include the sending and receiving of MIDI Note-On and Note-Off messages from each mute switch on the console, so that muting a channel will send out a Note-Off command and un-muting will send a Note-On. (Or, working in reverse, channels can be turned on and off by sending Note messages into the console). A useful application of this facility would be to trigger an outboard sampler by un-muting the input channel to which it is connected. Pressing the mute switch on the console would then have the dual function of turning on the audio input from the sampler, and playing the actual sound effect.

The possibilities are almost endless with MIDI control, as more and more equipment includes a MIDI interface.

The following pages give more detailed information about actually using the MIDI/Scene Set module.

# Mute Scenes/Mute Groups & MIDI Section

This module has two distinct functional areas: The Mute Scenes Controller and the M1-8 buttons (some controls are shared by these two areas).

## Mute Scenes Controller

The Mute Scenes controller is able to store the Cuts (mutes) for up to 128 different scenes (1 to 128). There is a further, non-standard, scene called ALL which appears on the display between 128 and 1. This allows you to store the same cuts in all of the scenes 1 to 128 (see page 4.25). In addition, MIDI Program Change with channel may be stored for each scene.

1 The 3-digit 7-segment display. This primarily displays the current scene number, information relating to the scene number, and information relating to the MIDI controls. It is also used to display the preview scene number, indicate when changes to the cuts have been made (by flashing the decimal points), and it is used to prompt the user for confirmation that changes are to be stored.

2 The **Up** key is used to increment the scene number as shown in the 7-segment display. It is also used as a “**Yes**” button to confirm that you wish to store changes. Holding the key down for longer than one second will cause the display to increment at high speed.

3 The **Down** key is used to decrement the scene number as shown in the 7-segment display. It is also used as a “**No**” button to allow you not to store changes. Holding the key down for longer than one second will cause the display to decrement at high speed.

4 Whenever the Up or Down key is pressed the scene number will change. However, the Cuts for that scene number will not be activated until you press **RECALL**. Note that until you press RECALL, the numbers in the display will flash to remind you that the Scene number which is displayed is not active on the desk. Holding the RECALL button down and then pressing UP or DOWN will cause each Scene to be recalled as soon as its number appears on the display.

5 The **STORE** button is used to store changes made to scenes. For each scene number it also stores the MIDI Global Channel Number, and the MIDI program-change value and channel. (Note: STORE and RECALL are illuminated if any parameter (cuts or MIDI) is different from the recalled scene.)

6 The **PROG CHANGE** button allows you to view and change the MIDI program change number and the MIDI channel used for **sending** program changes. After you have pressed the PROG CHANGE button, which latches electronically, the change number is displayed. The program change message value (1 to 128) may be changed using the Up/Down buttons (note: the actual MIDI number which is sent is in the range 0 - 127, i.e one less than the displayed value. Due to the variations in how various equipment manufacturers interpret program change numbers, the K2's displayed program change number may or may not correspond to the displayed program number of the external equipment being controlled). As changes are made, the appropriate program change is sent. The MIDI channel number may be viewed by pressing and holding the MIDI CHANNEL button. The channel number may be changed by using the Up/Down buttons.

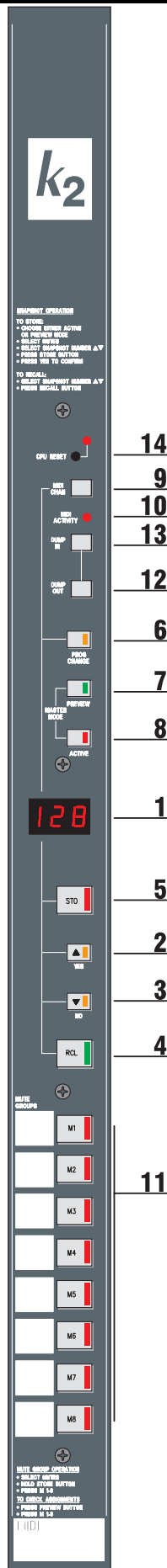



The **CPU RESET** button is available via a screwdriver hole. It may be latched in to disable the MIDI Module in the highly unlikely event of a CPU failure (all console mutes can be operated manually if the CPU is disabled).

**7** The **PREVIEW** button allows you to preview and change any values in a scene without affecting the current status of the console. This is a useful function during live performances.

**8** The **ACTIVE** button returns the console to Active mode. In this mode, pressing any CUT button will affect the audio in the normal way.

**9** Pressing the **MIDI CHANNEL** button causes the Global MIDI Channel Number to be displayed. This is the channel on which Note ON and Note Off events are transmitted and received, and on which Program Change messages are **received**. This may be set to one of 1 to 16 or ANY. This is done by using the Up and/or Down buttons. Note that if the MIDI CHANNEL is set to ANY no Note On or Note Off data will be sent, but Program Changes will be received regardless of their channel.

**10**

The **MIDI ACTIVITY** LED illuminates whenever MIDI information is transmitted or received by the console. This is useful when setting-up MIDI systems, e.g. to confirm that connections are good etc.

### M1-M8 Buttons

**11** The 8 Mute Group or Mute Scene buttons. See pages 4.26 to 4.29 for details.

### Saving and Loading The Memory

The module's internal battery-backed RAM (Random Access Memory) holds all the data for up to 128 scenes. This memory data may be "dumped" in to an external storage device, so that another set of scenes may be programmed in whilst retaining a backup of the original set of scenes. This is done by using the MIDI System universal bulk dump method. Various devices are available on which to store the dumped data; these include stand-alone MIDI bulk-dump recorders, and many sequencer packages or keyboards.

**12** Pressing the **DUMP OUT** button triggers a system universal bulk dump of the console's RAM via the MIDI output. The 7-segment display indicates three continuously illuminated bars to show the duration of the outgoing MIDI data. The MIDI activity LED will also light.

**13** Pressing the **DUMP IN** button primes the console to accept a system universal bulk dump of the RAM into the MIDI input. When the DUMP IN button has not been pressed, the RAM is protected, and cannot be overwritten by an incoming bulk dump. When you do press the DUMP IN button the 7-segment display shows three flashing bars, which stop flashing while incoming MIDI data is being received. At the end of the dump, the RAM is protected again, and the 7-segment display returns to the scene number display. To abort the DUMP IN procedure (e.g. if no data is received), the DUMP IN button may be pressed while the flashing bar is displayed. The 7-segment display returns to the scene number display.



---

The DUMP IN button should not be pressed while data is being received, otherwise the data will not be properly restored.  
The MIDI Activity LED will indicate whether or not data is being received.

**I4** The **CPU RESET** button is available via a screwdriver hole. It may be latched in to disable the MIDI Module in the highly unlikely event of a CPU failure (all console mutes can be operated manually if the CPU is disabled).

---

# Storing Mute Scenes

---

Mute Scenes may be stored using two alternative methods:

---

## Active Mode

This is the default mode and is selected by pressing the ACTIVE button, but it is also a “live” mode, that is, any cuts which you select will affect their channels immediately.

Mute scenes are programmed in this mode as follows:

Press the required cut buttons on any of the input channels, or group or matrix outputs. At this point the 7-segment display will show 3 flashing dots (this indicates that a change to the cuts has taken place), and the STORE and RECALL buttons will also illuminate. Next, select a Scene number by pressing the Up or Down buttons. There are 128 scenes(+ ALL); note that the UP and DOWN buttons will wrap around, i.e. if scene 128 is displayed and you press UP, the display will show scene ALL, when you press UP again the display will show scene 1. When the scene number is correct press the Store Button. The display will cycle through “YES”, “NO” and the scene number which is about to be overwritten. Press YES to confirm that you wish to store this Scene. If you press NO, the scene number will revert to the number which was shown prior to the changes, and the changes will not be stored.

---

## Preview Mode

Preview Mode is selected by pressing PREVIEW. This mode is not “live”, that is, any cuts which you select will not cut the audio signal, but they will be shown on the Preview LEDs adjacent to the CUT switches in question. We recommend using this mode when editing scenes during a live performance. The procedure for storing the mutes is the same as for the Active Mode described above.

---

## The 'ALL' Scene

---

The ALL scene allows selected data to be copied uniformly across all 128 scenes, to facilitate “global” setting of the console (e.g. storing the mute status to “all off” on all scenes). The currently displayed mute status or parameter value will be copied to all scenes when store is pressed.

---

### Example 1

To copy a setup of mutes to all scenes, for use as a starting point when programming:

1. Select either Active or Preview mode, using the Preview button.
  2. Use the Up/Down and Recall buttons to select and recall the “ALL” scene.
  3. Set up the required combination of input or output mutes by pressing the console’s mute buttons.
  4. Press STORE. The display scrolls the message “COPY TO ALL -YES-NO”.
  5. Confirm the Store by pressing the “Yes” button. The display scrolls the message “YES-NO-ALL”. Press the Yes button again to double confirm the Store. The mute setup will be copied into all scenes, overriding any previously stored mute scenes.
- 

### Example 2

To change the MIDI channel for program changes on all scenes:

1. Select either Active or Preview mode, using the Active or Preview buttons.
2. Use the Up/Down and Recall buttons to select and recall the “ALL” scene.
3. Press the Prog Change button -the 7-segment display changes to show the currently stored program number (this will be the same as the scene number as a default setting from the factory).
4. Press and hold the MIDI Channel button.
5. Continue to hold the MIDI Channel button whilst using the Up/Down buttons to select the required channel number on the display.
6. Still holding the MIDI Channel button, press STORE. The display scrolls the message “CHAN TO ALL -YES-NO”.
7. Confirm the Store by pressing the “Yes” button. The display scrolls the message “YES-NO-ALL”. Press the Yes button again to double confirm the Store. The selected MIDI channel for Program Changes will be copied into all scenes, overriding the previous setting.

Note that care is needed when using ALL due to the effect it has on scenes which are not currently selected. (This is the reason for the double-confirm). Once the “Copy to All” message has been double confirmed, it cannot be reversed. The only way to restore the previous setup is to either go through each scene and manually change the parameters, storing each change, or reload the console’s RAM memory, if this has been backed up using the bulk dump facility.

---

# Introduction to the M1 - M8 Buttons

---

The M1 - M8 buttons can be used in two ways, depending on the application.

---

## Mute Groups

This mode may be thought of as the software version of the traditional “mute groups”, and is the default mode for the M1-M8 buttons when the console leaves the factory.

This mode provides the facility to use the M1 - M8 buttons on the bottom of the midi module as conventional Mute Groups. This facility simplifies the creation of mute groups, and is well suited to live music applications where the engineer does not wish to get involved with programming mute scenes using the 7-segment display. This facility also allows mute groups to be toggled on and off and to be “layered” in the same way as with a conventional mute group system.

The Mute Groups mode separates the M1 - M8 buttons from the 128 scenes, giving in effect an extra 8 “special” scenes which are used for mute grouping. Thus the M1 - M8 buttons can be used independently of the rest of the midi module, simplifying operation.

---

## Mute Scenes

In this mode the M1 - M8 buttons simply act as instant recall buttons for any of the 128 scenes which have already been stored using the 7-segment display and STORE button. This is useful in a theatre environment where a certain number of scenes need to be recalled often: finding the number on the 7-segment display could be laborious.

Only one scene at a time can be recalled with this mode.

---

## Switching between Mute Scenes mode and Mute Groups mode

The user only has to decide once which mode is preferred: the console remembers which mode is in use every time it is powered up, unless you want to change mode for any reason.

Swapping between Mute Group mode and Mute Scenes mode is done at power up. To change from one mode to the other you must hold down the M1 button during the power-up sequence. The new mode will then remain active during each mixing session thereafter, until the M1/power-up operation is performed again to swap to the other mode.

The default mode when leaving the factory is Mute Group Mode, and the instructions printed on the front panel refer to this mode only.

---

# Using The M1 - M8 Buttons In Mute Groups Mode

---

## How To Set Up A Mute Group

Make sure that the console is in “Mute Group” mode (see “Switching between Mute Scenes Mode and Mute Groups Mode” on page 4.26). The console should be in this mode when it leaves the factory.

To set up a Mute Group you can be in either PREVIEW or ACTIVE mode. Select the mutes required in the mute group by pressing the appropriate CUT switches (If in preview mode this will cause the Preview LED to start flashing as an indication of selection. The channel audio will not be affected).

To store these mutes as Mute Group 1 you should hold down the STORE button and press the M1 button. The Store operation does not need to be confirmed. Similarly if you want to assign the active mutes as Mute Group 8 you should hold down the STORE button and press the M8 button. This principal applies to assigning mutes to any of the buttons M1-M8.

N.B. Each individual mute may belong to one or more Mute Groups. Alternatively you may choose not to assign a particular mute to any groups at all.

---

## Using The Mute Groups

Once mute groups have been assigned as described above, they can be checked if required by selecting Preview mode and then pressing the M1 - M8 buttons. The Preview LEDs will flash to confirm which channels are assigned to the selected mute group. To use the mute groups during the performance, select Active mode again.

Operating the M1 - M8 buttons now will cause the selected channels to CUT. (Preview mode can be re-entered at any time during the performance, for checking purposes).

---

## How Mute Groups Behave In Practice

Each of the buttons M1-M8 will be illuminated when that group is active. Pressing one of the buttons M1-M8 to select a Mute Group will mute all channels assigned to that group. Pressing M1-M8 to deactivate the group will un-mute the assigned channels. If more than one mute Group is selected at a time, the result will be a “layering” or “additive” effect.

In addition, channel CUTs can still be unmuted locally after they have been cut by a Mute Group.

---

## Mute Groups & Scene Recall

The Scene-set system (if used) takes priority over the Mute Group system. When a Mute Scene is recalled by selecting one of the 128 scenes and pressing the RECALL button, any Mute Groups which are active at the time are deactivated. This also applies if the Mute Scene is recalled by an incoming MIDI Program Change message.

Once a scene has been recalled however, Mute Groups can then be activated and will appear to “layer” on top of the existing scene.

---

## Mute Groups and Program Change Messages

Note that program changes cannot be stored or recalled from the M1 - M8 buttons when in Mute Group Mode. If program changes are required, a scene must be recalled using the 7-segment display, or the M1 - M8 buttons must be switched to Mute Scenes mode.

---

## Using The M1 - M8 Buttons In Mute Scenes Mode

---

When the console is in Mute Scenes mode (see “Switching between Mute Scenes Mode and Mute Groups Mode” on page 4.26), the M1 - M8 buttons are designed to allow “instant” recall of any mute scene, without having to use the Up/Down buttons and 7-segment display to find the scene and then recall it with the “Recall” button.

When Mute Scenes mode is first selected, the M1 - M8 buttons are pre-programmed to select and recall scenes 1-8, so all that is necessary to use them is to store required mute settings into each scene of 1-8. (See “Storing Mute Scenes” on page 4.23). The various combinations of mutes can then be recalled at will by simply pressing the M1 - M8 buttons. The buttons have an “interlocking” action, i.e. you can only select one at a time, any selection cancels the previous one. (Note: if overlapping Mute Scenes are required use Mute Group mode - see page 4.27)

Once scenes have been stored, the effect of pressing the M1 - M8 buttons is then to instantly select and recall the corresponding scene, in one operation. Any program changes stored with the scene will also be recalled exactly as if the scene had been recalled using Up/Down and Recall.

For more advanced use, the M1 - M8 buttons can be reassigned from their factory set defaults of scenes 1-8, to any other scene numbers. The only restriction is that you cannot assign a given M1 - M8 button to more than one scene at the same time, and you cannot assign more than one M1 - M8 button to a given scene number.

This would be useful in a theatre production to provide fast access to given scenes which need to be recalled frequently, for example during rehearsals.

### **To reassign the M1 - M8 buttons to any scene number:**

- 1 Select and recall the required scene using the Up/Down and Recall buttons.
- 2 Press and hold down the Store button, and then momentarily press the required M1 - M8 button.
- 3 Release the Store button. The M1 - M8 button has now been assigned to the current scene.

Note that if the above operation is repeated with the same M1 - M8 button, the button will be deassigned and will not be assigned to any scene. The M1 - M8 buttons can all be set to “no scene” in this way if required.

---

## Storing MIDI Parameters with Mute Scenes

---

At the same time as creating a mute scene, a number of other parameters can be stored.

These are:

- Program change number for the scene
- MIDI channel number for transmission of program change messages
- Global receive channel for incoming MIDI Note on/off messages and reception of Program Change messages.

All these parameters can be stored at the same time, or edited individually without changing the others. Storing/editing of these parameters can be carried out in either Active Mode or Preview mode, as for the mutes.

---

### Example

Suppose for scene number 12 you want to store the following configuration:

Program change **40**, on MIDI channel **3**

1. Select either Active or Preview mode by pressing the PREVIEW button.
2. Select and recall the Scene 12, using the up/down buttons and RECALL button.
3. Press the PROG CHANGE button, which will illuminate. The 7-segment display now shows the currently stored program change number for scene 12. (If the console is new, the program change numbers will be factory-set to be the same as scene numbers, until altered)
4. Use the up/down buttons to change the program number to **40**. Note that if you are in Active mode, Program Change messages will be sent out as you increment the display, enabling you to observe the change happening on the outboard equipment. This does not happen if you are in Preview mode.
5. Press and hold the MIDI CHANNEL button at the top of the module. The 7-segment display now shows the currently stored Program Change MIDI channel for scene 12.
6. Use the Up/Down buttons to set the MIDI channel to channel **3**. When 3 is shown in the display, release the MIDI Channel button.
7. Press the STORE button to save the changes you have made into scene 12's memory location. You are prompted by the display to confirm or abort the store operation, by pressing the Yes or No buttons.

---

## Setting the Global MIDI Receive/Note On/Off Channel

---

As described above, the MIDI channel for Program change *transmit* is set and stored for each scene.

The MIDI channel for the *receiving* of Program Changes and both the *transmitting* and *receiving* of Note On and Note Off messages can also be set and stored in the same way.

To set the Global Receive/Note On/Off channel:

1. Make sure that the Program Change switch is not illuminated.
2. Press and hold the MIDI channel switch at the top of the module.
3. Use the Up/Down buttons to select a channel between 1 and 16, or select “ANY”, which means that the console will “listen” on all MIDI channels, but will not transmit on any channel.
4. Release the MIDI channel button, and press the STORE button. The display scrolls the message “YES-NO-Scene Number”. Press the Yes button to confirm the Store.

The channel is factory set to channel 1 on all scenes.



---

## **Editing MIDI Parameters in Mute Scenes**

---

If you want to change any of the MIDI parameters individually within a scene, follow the instructions in the examples on pages 4.29 and 4.30, but omit the steps which refer to parameters you do not wish to change. You can change the value of just one parameter if you wish, and then press store. The scene will then be updated with just the changed information. (The other parameters will be updated as well, but as you haven't changed them, this won't make any difference).

You can also make changes to the console mutes while editing MIDI parameters, and these will be stored along with the MIDI parameters when the Store button is pressed.

If editing is required during a performance for any reason, Preview mode should be selected, so that the required scene can be recalled for editing without disturbing the existing status of the console.

---

## Table of MIDI Note Numbers sent/received by K2 mute switches

---

MIDI Note Number	K2 Cut Switch	MIDI Note Number	K2 Cut Switch
0	Stereo Input 1	30	Mono Input 11
1	Stereo Input 2	31	Mono Input 12
2	Stereo Input 3	32	Mono Input 13
3	Stereo Input 4	33	Mono Input 14
4	Grp 1	34	Mono Input 15
5	FX 1	35	Mono Input 16
6	Grp 2	36	Mono Input 17
7	FX 2	37	Mono Input 18
8	Grp 3	38	Mono Input 19
9	FX 3	39	Mono Input 20
10	Grp 4	40	Mono Input 21
11	FX 4	41	Mono Input 22
12	Grp 5	42	Mono Input 23
13	MTX 1	43	Mono Input 24
14	Grp 6	44	Mono Input 25
15	MTX 2	45	Mono Input 26
16	Grp 7	46	Mono Input 27
17	MTX 3	47	Mono Input 28
18	Grp 8	48	Mono Input 29
19	MTX 4	49	Mono Input 30
20	Mono Input 1	50	Mono Input 31
21	Mono Input 2	51	Mono Input 32
22	Mono Input 3	52	Mono Input 33
23	Mono Input 4	53	Mono Input 34
24	Mono Input 5	54	Mono Input 35
25	Mono Input 6	55	Mono Input 36
26	Mono Input 7	56	Mono Input 37
27	Mono Input 8	57	Mono Input 38
22	Mono Input 9	58	Mono Input 39
29	Mono Input 10	59	Mono Input 40



# MIDI Implementation Chart

Function	Transmitted	Recognised	Remarks	
Basic Channel	Default Changed	1 1-16	1 1-16	
Mode	Default Messages Altered	MODE3 X X	MODE3 X X	
Note Number:	True Voice	0-59 X	0-59 X	See Note 1
Velocity	Note On Note Off	X X	X X	Note ON. Velocity 1-27 = Channel not muted Note ON. Velocity 0 = Channel muted Note Off. Velocity 1-27 = Channel muted
After Touch	Keys Chs	X X	X X	
Pitch Bend		X	X	
Control Change		X	X	
Program Change	True#	0 - 127 X	0 - 127 X	See Note 2
System Exclusive		O	O	See Note 3
System Common	Song Position Song Select Tune	X X X	X X X	
System Real Time	Clock Command	X X	X X	
Aux Messages	Local On/Off All Notes Off Active Sense Reset	X X X X	X X X X	

**Notes**

Note 1. Note Numbers  
 Note Numbers 0 - 3 correspond to the mutes on Stereo Inputs 1 - 3  
 Note Numbers 4 - 19 correspond to the mutes on Matrix and Groups  
 Note Numbers 20 - 59 correspond to the mutes on inputs 1 - 40

Note 2. Program Change  
 Program Change Numbers 0 - 127 are transmitted when scenes 1 - 128 are recalled.  
 When Program change Numbers 0 - 127 are received, scenes 1 - 128 are recalled.

Note 3. System Exclusive. The system exclusive file format used to dump the scenes to an external computer for backup purposes is as follows:  
 Header: f0 39 7f 07 01 39 'MIDI' 00 00 03 04 f7  
 Start Packet: f0 39 7f 07 02 00 17 'Soundcraft K2' <Version no> f7  
 Data packets containing scenes: f0 39 7f 07 02 <Packet count> <data size> <data> <checksum> f7  
 End of file: f0 39 7f 7b 00 f7  
 (Where '...' indicates ASCII code for text, & '<...>' indicates hexadecimal data)

Mode 1: OMNI ON, POLY  
 Mode 3: OMNI OFF, POLY

Mode 2: OMNI ON, MONO  
 Mode 4: OMNI OFF, MONO

O: Yes  
 X: No



# **Specification**

# K2 Specification

	Module	Signal	Conn.	Pin	Nom Level	Max Level	Impedance
Inputs	Mono Input	Mic I/P	XLR	Pin 1 - Ground Pin 2 - Signal Hot Pin 3 - Signal Cold	-70 to -2dBu -20 to +10dBu	+30dBu	1.6k $\Omega$
		Hi-Z	TRS	Tip - Signal Hot Ring - Signal Cold Sleeve - Ground	-20 to +10dBu	+30dBu	>10k $\Omega$
	Stereo Input	Line I/P (Left & Right)	TRS	Tip - Signal Hot Ring - Signal Cold Sleeve - Ground	-20 to +10dBu	+30dBu	>10k $\Omega$
	FX Return	Line I/P (Left & Right)	TRS	Tip - Signal Hot Ring - Signal Cold Sleeve - Ground	+4dBu/ -10dBV	+26dBu/ +12dBV	>10k $\Omega$
	Master	External Talkback Mic I/P	XLR	Pin 1 - Ground Pin 2 - Signal Hot Pin 3 - Signal Cold	-20 to -50dBu	0dBu	2k $\Omega$
		Talkback I/P	XLR	Pin 1 - Ground Pin 2 - Signal Hot Pin 3 - Signal Cold	+4dBu	+26dBu	>10k $\Omega$
2-Track I/Ps		TRS	Tip - Signal Hot Ring - Signal Cold Sleeve - Ground	+4dBu/ -10dBV	+26dBu/ +12dBV	>10k $\Omega$	
Insert points	Mono Input	Channel Insert	TRS	Tip - Return Ring - Send Sleeve - Ground	Send -2dBu Return -2dBu	+21dBu	Send <75 $\Omega$ Return >10k $\Omega$
	Stereo Input (L&R)	Channel Insert	TRS		Send -2dBu Return -2dBu	+21dBu	Send <75 $\Omega$ Return >10k $\Omega$
	Group/Aux Master	Group/Aux Insert	TRS		Send -2dBu Return -2dBu	+21dBu	Send <75 $\Omega$ Return >10k $\Omega$
	Output Master	Main Mono, L & R Inserts	TRS		Send -2dBu Return -2dBu	+21dBu	Send <75 $\Omega$ Return >10k $\Omega$
Outputs	Mono Input	Direct Output	TRS	Tip - Signal Hot Ring - Ground Sense Sleeve - Ground	-2dBu	+21dBu (into 2k $\Omega$ )	<75 $\Omega$
	Matrix	Matrix Output	XLR	Pin 1 - Ground Pin 2 - Signal Hot Pin 3 - Signal Cold	+4dBu	+26dBu (into 1k $\Omega$ )	<75 $\Omega$
	Group Master	Group Output	XLR	Pin 1 - Ground Pin 2 - Signal Hot Pin 3 - Signal Cold	+4dBu	+26dBu (into 1k $\Omega$ )	<75 $\Omega$
	Aux Master	Aux Output	TRS	Tip - Signal Hot Ring - Signal Cold Sleeve - Ground	+4dBu	+26dBu (into 1k $\Omega$ )	<75 $\Omega$
	Output Master	L/R/Mono Outputs	XLR	Pin 1 - Ground Pin 2 - Signal Hot Pin 3 - Signal Cold	+4dBu	+26dBu (into 1k $\Omega$ )	<75 $\Omega$
		TB Ext Output	XLR	Pin 1 - Ground Pin 2 - Signal Hot Pin 3 - Signal Cold	+4dBu	+26dBu (into 1k $\Omega$ )	<75 $\Omega$
		Oscillator Output	TRS	Tip - Signal Hot Ring - Ground Sense Sleeve - Ground	+4dBu	+14dBu (into 1k $\Omega$ )	<75 $\Omega$
		Headphones Output	TRS	Tip - Left Ring - Right Sleeve - Ground	+4dBu	+20dBu (into 600 $\Omega$ ) 0dBu (into 8 $\Omega$ )	50 $\Omega$

# K2 Specification

Frequency Response	Any input to any output (measured at up to +50dB gain):	+0/-0.5dB, 20Hz - 20kHz
T.H.D. and Noise	High Impedance I/P to Group or Mix O/P (measured at +20dBu Output):	< 0.005% THD @ 1kHz
Mic Input E.I.N.	22Hz - 22kHz bandwidth, unweighted:	< -127dBu (150Ω source)
Residual Noise	Mix Output; no inputs routed, Mix fader @ 0dB: Grp Output; no inputs routed, Mix fader @ 0dB:	-97dBu -90dBu
Bus Noise	Mix Output; 40 channels routed, input faders @ -∞, Mix fader 0dB: Grp Output; 40 channels routed, input faders @ -∞, Grp fader 0dB: Aux Output; 40 channels routed, input faders @ -∞, Aux fader 0dB: Matrix Output; Matrix Inputs down, Matrix master 0dB:	< -84dBu < -84dBu < -80dBu < -82dBu
Crosstalk	1kHz, +20dBu input signals Muting Attenuation - I/P to Mix: Muting Attenuation - Stereo I/P to Mix: Input Fader Attenuation: Master Fader Attenuation: Input Pan-pot Attenuation	-88dB -88dB -101dB -80 dB -74 dB
CMRR	Mono Input, measured at Direct Output:	-52 dB @ 1kHz
Oscillator	63Hz to 10kHz/Pink Noise, variable level.	
HP Filter (Mono Input)	20-400Hz, 12dB/octave.	
EQ (Mono Input)	HF: 12kHz, +/-15dB HMF: 400 - 12kHz, +/-15dB, Q 1.3/2.7 LMF: 40 - 1.2kHz, +/-15dB, Q 1.3/2.7 LF: 60Hz, +/-15dB	
Metering	Overbridge: 8 VU Meters monitoring Group/Aux/FX Returns/Matrix + 3 VU Meters monitoring Left Mix, Right Mix & Mono (centre) Mix/PFL/AFL  Mono Input: 8-LED bargraph + Peak LED Stereo Input: 8-LED bargraph + Peak LED	
Power Consumption	40 Ch Console: each 17V rail takes 3.8A (nominal)(measured without Littlelites connected)	
Weight	24 Ch - 40kg (88lbs), 32 Ch - 50kg (110lbs), 40 Ch - 60kg (132lbs)	
Operating Conditions	Temperature Range +10°C to +30°C Relative Humidity 0% to 80%	

